

NATIONAL REGISTER OF HISTORIC PLACES  
INVENTORY -- NOMINATION FORM

RECEIVED  
DATE ENTERED

USE TO COPY

SEE INSTRUCTIONS IN HOW TO COMPLETE NATIONAL REGISTER FORMS  
TYPE ALL ENTRIES -- COMPLETE APPLICABLE SECTIONS

1 NAME

HISTORIC 3 Mud River Covered Bridge

MILTON COVERED BRIDGE

AND/OR COMMON

2 LOCATION

STREET & NUMBER On Cabell County Route 25 about 1/5 mile south of U.S. Route 60

CITY, TOWN  
Milton

VICINITY OF

NOT FOR PUBLICATION

CONGRESSIONAL DISTRICT  
Fourth

STATE  
West Virginia

CODE  
54

COUNTY  
Cabell

CODE  
011

3 CLASSIFICATION

CATEGORY	OWNERSHIP	STATUS	PRESENT USE
<input type="checkbox"/> DISTRICT	<input checked="" type="checkbox"/> PUBLIC	<input checked="" type="checkbox"/> OCCUPIED	<input type="checkbox"/> AGRICULTURE <input type="checkbox"/> MUSEUM
<input type="checkbox"/> BUILDING(S)	<input type="checkbox"/> PRIVATE	<input type="checkbox"/> UNOCCUPIED	<input type="checkbox"/> COMMERCIAL <input type="checkbox"/> PARK
<input checked="" type="checkbox"/> STRUCTURE	<input type="checkbox"/> BOTH	<input type="checkbox"/> WORK IN PROGRESS	<input type="checkbox"/> EDUCATIONAL <input type="checkbox"/> PRIVATE RESIDENCE
<input type="checkbox"/> SITE	<input type="checkbox"/> PUBLIC ACQUISITION	<input type="checkbox"/> ACCESSIBLE	<input type="checkbox"/> ENTERTAINMENT <input type="checkbox"/> RELIGIOUS
<input type="checkbox"/> OBJECT	<input type="checkbox"/> IN PROCESS	<input checked="" type="checkbox"/> YES: RESTRICTED	<input type="checkbox"/> GOVERNMENT <input type="checkbox"/> SCIENTIFIC
	<input type="checkbox"/> BEING CONSIDERED	<input type="checkbox"/> YES: UNRESTRICTED	<input type="checkbox"/> INDUSTRIAL <input checked="" type="checkbox"/> TRANSPORTATION
		<input type="checkbox"/> NO	<input type="checkbox"/> MILITARY <input type="checkbox"/> OTHER:

4 OWNER OF PROPERTY

NAME  
State of West Virginia (Department of Highways)

STREET & NUMBER  
1900 Washington Street, East

CITY, TOWN  
Charleston

VICINITY OF

STATE  
West Virginia

5 LOCATION OF LEGAL DESCRIPTION

COURTHOUSE,  
REGISTRY OF DEEDS, ETC. Cabell County Courthouse

STREET & NUMBER  
4th Avenue and 8th Street

CITY, TOWN  
Huntington

STATE  
West Virginia

6 REPRESENTATION IN EXISTING SURVEYS

TITLE

DATE

FEDERAL STATE COUNTY LOCAL

DEPOSITORY FOR  
SURVEY RECORDS

CITY, TOWN

STATE

# DESCRIPTION

CONDITION		CHECK ONE	CHECK ONE
<input type="checkbox"/> EXCELLENT	<input type="checkbox"/> DETERIORATED	<input type="checkbox"/> UNALTERED	<input checked="" type="checkbox"/> ORIGINAL SITE
<input checked="" type="checkbox"/> GOOD	<input type="checkbox"/> RUINS	<input checked="" type="checkbox"/> ALTERED	<input type="checkbox"/> MOVED    DATE _____
<input type="checkbox"/> FAIR	<input type="checkbox"/> UNEXPOSED		

## DESCRIBE THE PRESENT AND ORIGINAL (IF KNOWN) PHYSICAL APPEARANCE

The Mud River Covered Bridge at Milton, Cabell County, is a single-span, modified Howe truss structure which has incorporated additional support through the use of a central arch. Probably constructed in the second half of the nineteenth century, the bridge now sits atop its old cut-stone abutments near the river's banks. These are complemented by the strength of steel girders placed on both the river and bank sides of the original abutments in recent years.

Structural framing of the bridge features a central arch which ties into the first and tenth "X"-shaped trusses. This slight modification of the Howe pattern adds strength to the structure. The actual design includes double supports on either side of the iron tie-rods which Howe devised for use instead of wooden beams. The heavy supports cross at mid-point between bridge floor and roof with the "X"-pattern repeated between the siding and the floor boards. Roof supports consist of iron rods placed about mid-way between each of the series of side trusses. These rods are met by wooden beams which form another "X"-pattern along the roof. Siding is vertical and reaches within about one foot of the roof overhang. The roof is of cedar shakes.

From the time of its construction until 1971, the bridge apparently underwent only minor repairs. In 1971, however, the West Virginia Department of Highways, the agency responsible for maintenance, undertook the task of structural restoration at the urging of the Covered Bridge Garden Club of Milton. Care was taken not to destroy the integrity of design, and beams in need of replacement or repair were matched for size and placed in the original positions. The bridge floor is now underpinned with steel girders, and extra steel abutments have been added. New siding and a new floor were constructed. The roof supports were completely removed and a new roof built.

Although many of the bridge supports had to be replaced during renovation and the bridge was completely stripped of siding and roof, the integrity of design and location was insured. Flooring was strengthened and the structure upgraded to handle common loads. Mud River Covered Bridge is presently in good condition and maintains its place as one of Milton's most historic structures.

The bridge is approximately 112 feet in length and 14 feet in width. Beams are of dimensions between 6" x 6" and 8" x 8", and the central arch is composed of four 6" x 4" planks.

# SIGNIFICANCE

PERIOD	AREAS OF SIGNIFICANCE -- CHECK AND JUSTIFY BELOW			
<input type="checkbox"/> PREHISTORIC	<input type="checkbox"/> ARCHEOLOGY-PREHISTORIC	<input type="checkbox"/> COMMUNITY PLANNING	<input type="checkbox"/> LANDSCAPE ARCHITECTURE	<input type="checkbox"/> RELIGION
<input type="checkbox"/> 1400-1499	<input type="checkbox"/> ARCHEOLOGY-HISTORIC	<input type="checkbox"/> CONSERVATION	<input type="checkbox"/> LAW	<input type="checkbox"/> SCIENCE
<input type="checkbox"/> 1500-1599	<input type="checkbox"/> AGRICULTURE	<input type="checkbox"/> ECONOMICS	<input type="checkbox"/> LITERATURE	<input type="checkbox"/> SCULPTURE
<input type="checkbox"/> 1600-1699	<input checked="" type="checkbox"/> ARCHITECTURE	<input type="checkbox"/> EDUCATION	<input type="checkbox"/> MILITARY	<input type="checkbox"/> SOCIAL/HUMANITARIAN
<input type="checkbox"/> 1700-1799	<input type="checkbox"/> ART	<input checked="" type="checkbox"/> ENGINEERING	<input type="checkbox"/> MUSIC	<input type="checkbox"/> THEATER
<input checked="" type="checkbox"/> 1800-1899	<input checked="" type="checkbox"/> COMMERCE	<input type="checkbox"/> EXPLORATION/SETTLEMENT	<input type="checkbox"/> PHILOSOPHY	<input checked="" type="checkbox"/> TRANSPORTATION
<input checked="" type="checkbox"/> 1900-	<input type="checkbox"/> COMMUNICATIONS	<input type="checkbox"/> INDUSTRY	<input type="checkbox"/> POLITICS/GOVERNMENT	<input type="checkbox"/> OTHER (SPECIFY)
		<input type="checkbox"/> INVENTION		

SPECIFIC DATES 1875-76

BUILDER/ARCHITECT

## STATEMENT OF SIGNIFICANCE

Mud River Covered Bridge stands about a century after it was constructed as a tribute to the engineering of wooden bridges and their place in the transportation network of a developing United States. The style or architecture of the structure is patterned after the innovations in the use of iron as a supporting material developed by William Howe, but this bridge uses the added strength of an arch. For a long while the commerce of the central part of Cabell County, West Virginia, depended upon this valuable link across the Mud River.

The town of Milton began growing and prospering with the coming of the Chesapeake and Ohio Railway in the early 1870s. Increased business activity required better means of transportation, so the Cabell County Court let a contract to construct a wooden bridge across the Mud River in late 1874. The local postmaster won at least part of the job of building the structure, and he and his workers brought it to completion by late 1875 or early 1876 despite high water in the spring. The bridge's prominence as a landmark became immediately clear, for when the town of Milton was incorporated in 1876, its boundary listing began "at the south side of the Milton bridge across the Mud River."

The construction was undertaken as a project of the county court. Bridge design is basically the pattern devised by William Howe about 1840, in that it incorporates the "X"-truss in wooden beams and the major vertical supports in iron tie rods rather than wood. The Mud River Bridge carries the basic style a little farther, though, for the trusses are doubled, two sets of crossbeams being placed between each set of tie rods. To provide additional strength, the structure has a wooden arch.

The Mud River Covered Bridge provided a greatly improved means of transportation and better flow of commerce in the central section of Cabell County when constructed. Even though it was built about the time of the laying of the Chesapeake and Ohio Railway through the area when the long distance traffic from east and west on the old James River and Kanawha Turnpike was much diminished, it facilitated the movement of goods and people to the railroad depots and around the surrounding countryside. Maintenance records from 1891 stress the importance of the structure to the area's commerce, for the county court was willing to pay \$110.09 for needed repairs. Since the bridge is located in an area of steep banks and rough terrain, fording the stream would have been difficult. Outlying farmers and townspeople alike would have appreciate the availability of such a key addition to the transportation system.

Milton, then, is privileged to have a usable covered bridge which is structurally sound and architecturally interesting. The engineering of the bridge was an advance in design and strength, for it improved the truss pattern developed by Howe with its double, "X"-shaped beams and added the support of an arch. The bridge is still an important link between the residential sections on either side of Mud River and is quite well maintained as an historic and practical attraction.

10-300a  
(10-74)

UNITED STATES DEPARTMENT OF THE INTERIOR  
NATIONAL PARK SERVICE

NATIONAL REGISTER OF HISTORIC PLACES  
INVENTORY -- NOMINATION FORM

FOR NPS USE ONLY

RECEIVED

DATE ENTERED

CONTINUATION SHEET

ITEM NUMBER

PAGE one

9. MAJOR BIBLIOGRAPHICAL REFERENCES (continued)

Lockwood, Mrs. George K. to James E. Harding, March 3, 1975. Material on file with the West Virginia Antiquities Commission, Old Mountainlair, West Virginia University, Morgantown, W.Va.

"Milton Landmark Being Restored." Cabell Record (Milton, W.Va.), June 23, 1971.

# MAJOR BIBLIOGRAPHICAL REFERENCES

Adkins, Mrs. Oneita H. to James E. Harding, February 28, 1975. Material on file with the West Virginia Antiquities Commission, Old Mountainlair, West Virginia University, Morgantown, W.Va.  
 Auvil, Myrtle. Covered Bridges of West Virginia: Past and Present. 2nd. ed. Parkersburg, W.Va.: McClain Printing Co., 1973. (pp. 49-54)  
 Huntington (W.Va.) Advertiser, Nov. 5, 1874; July 21, 1875; Dec. 17, 1875; Jan. 13, 1876.

## GEOGRAPHICAL DATA

ACREAGE OF NOMINATED PROPERTY 1/2 acre

UTM REFERENCES

A	1,7	4,0,0	5,4,0	4,2	5,4	0,4	0	B							
	ZONE	EASTING		NORTHING				ZONE	EASTING		NORTHING				
C								D							

VERBAL BOUNDARY DESCRIPTION

### LIST ALL STATES AND COUNTIES FOR PROPERTIES OVERLAPPING STATE OR COUNTY BOUNDARIES

STATE	CODE	COUNTY	CODE
STATE	CODE	COUNTY	CODE

## FORM PREPARED BY

NAME/TITLE

James E. Harding, Research Analyst

ORGANIZATION

West Virginia Antiquities Commission

DATE

March 27, 1975

STREET & NUMBER

Old Mountainlair, West Virginia University

TELEPHONE

(304) 292-1527

CITY OR TOWN

Morgantown

STATE

West Virginia

## STATE HISTORIC PRESERVATION OFFICER CERTIFICATION

THE EVALUATED SIGNIFICANCE OF THIS PROPERTY WITHIN THE STATE IS:

NATIONAL

STATE

LOCAL

As the designated State Historic Preservation Officer for the National Historic Preservation Act of 1966 (Public Law 89-665), I hereby nominate this property for inclusion in the National Register and certify that it has been evaluated according to the criteria and procedures set forth by the National Park Service.

FEDERAL REPRESENTATIVE SIGNATURE

*Edward M. Lewis*

TITLE West Virginia State Historic Preservation Officer

DATE

May 19, 1975

FOR NPS USE ONLY

I HEREBY CERTIFY THAT THIS PROPERTY IS INCLUDED IN THE NATIONAL REGISTER

DATE

DIRECTOR, OFFICE OF ARCHEOLOGY AND HISTORIC PRESERVATION

ATTEST:

DATE

KEEPER OF THE NATIONAL REGISTER

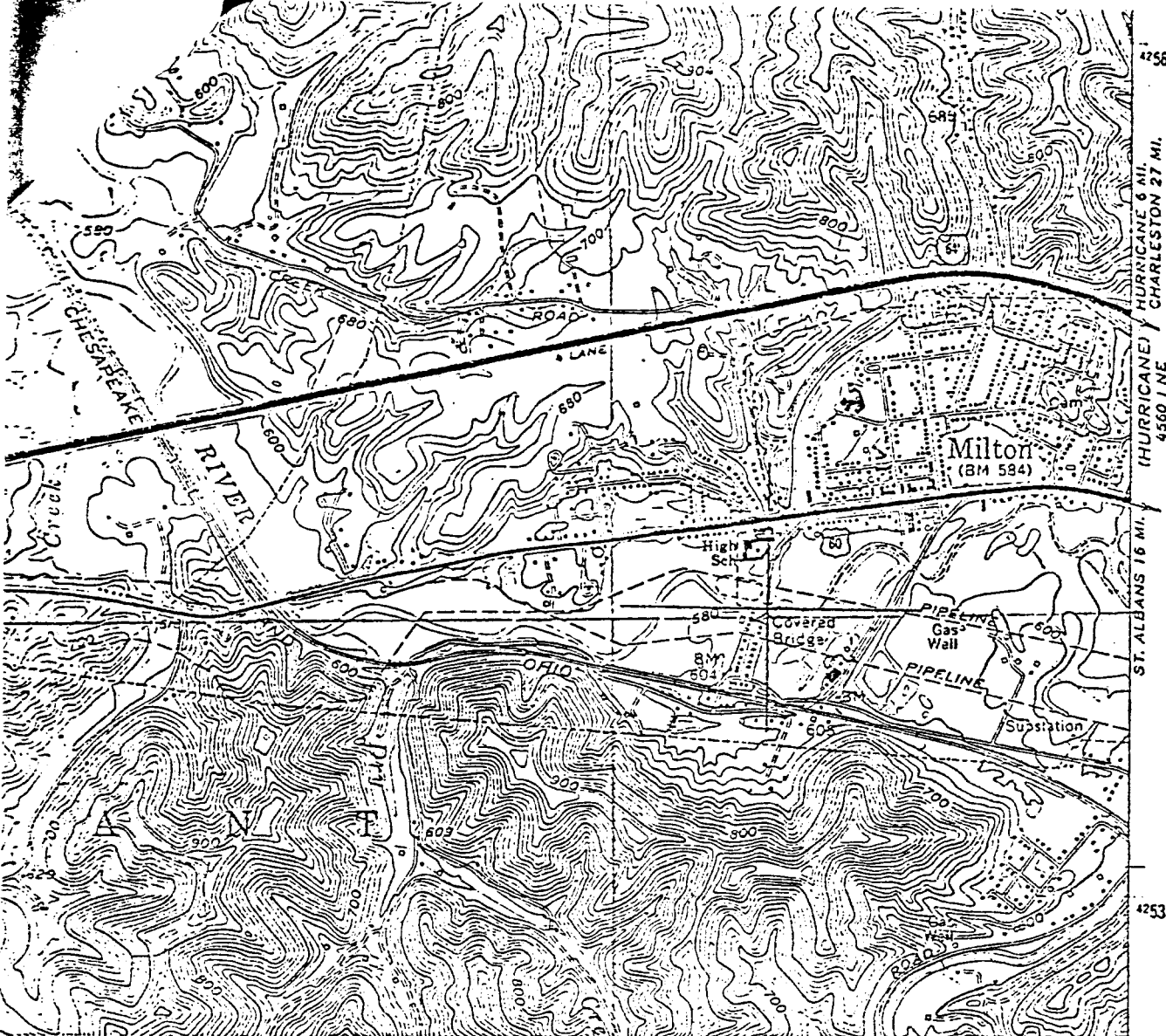

MUD RIVER CO  
 BRIDGE  
 MILTON, CABELL  
 WEST VIRGINIA  
 UTM REFERENCE  
 17/40640/400

Form No. 10-301  
 (Rev. 10-74)

UNITED STATES DEPARTMENT OF THE INTERIOR  
 NATIONAL PARK SERVICE

**NATIONAL REGISTER OF HISTORIC PLACES  
 PROPERTY MAP FORM**

FOR NPS USE ONLY
RECEIVED
DATE ENTERED

SEE INSTRUCTIONS IN HOW TO COMPLETE NATIONAL REGISTER FORMS  
 TYPE ALL ENTRIES -- ENCLOSE WITH MAP

**1 NAME**

HISTORIC Mud River Covered Bridge

AND/OR COMMON

**2 LOCATION**

CITY/TOWN Milton	VICINITY OF	COUNTY Cabell	STATE West Virginia
---------------------	-------------	------------------	------------------------

**3 MAP REFERENCE**

SOURCE U.S. Geological Survey  
 Milton, W.Va., 7.5' Quadrangle  
 SCALE 1:24000 DATE 1972

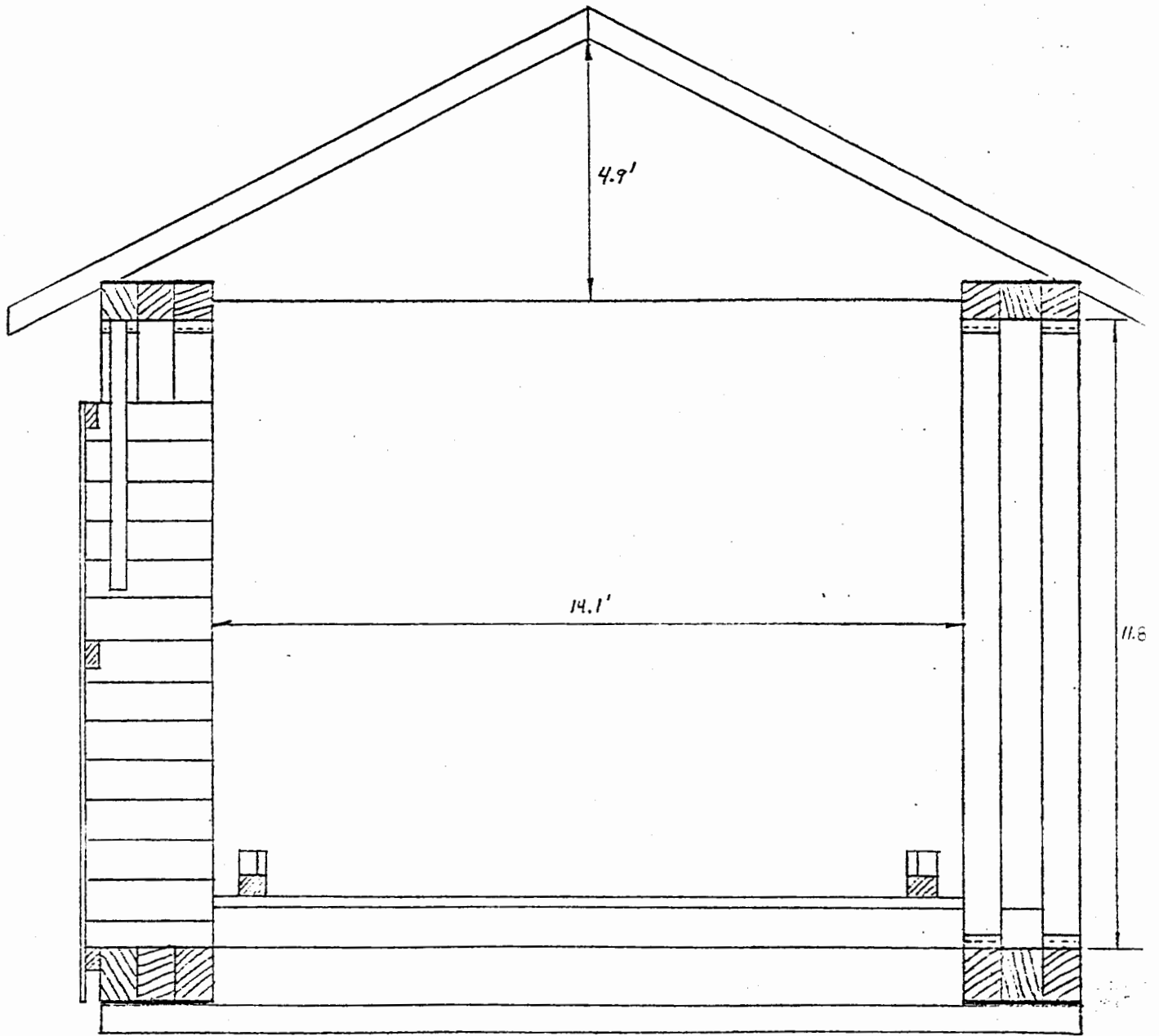

3. MILTON COVERED BRIDGE

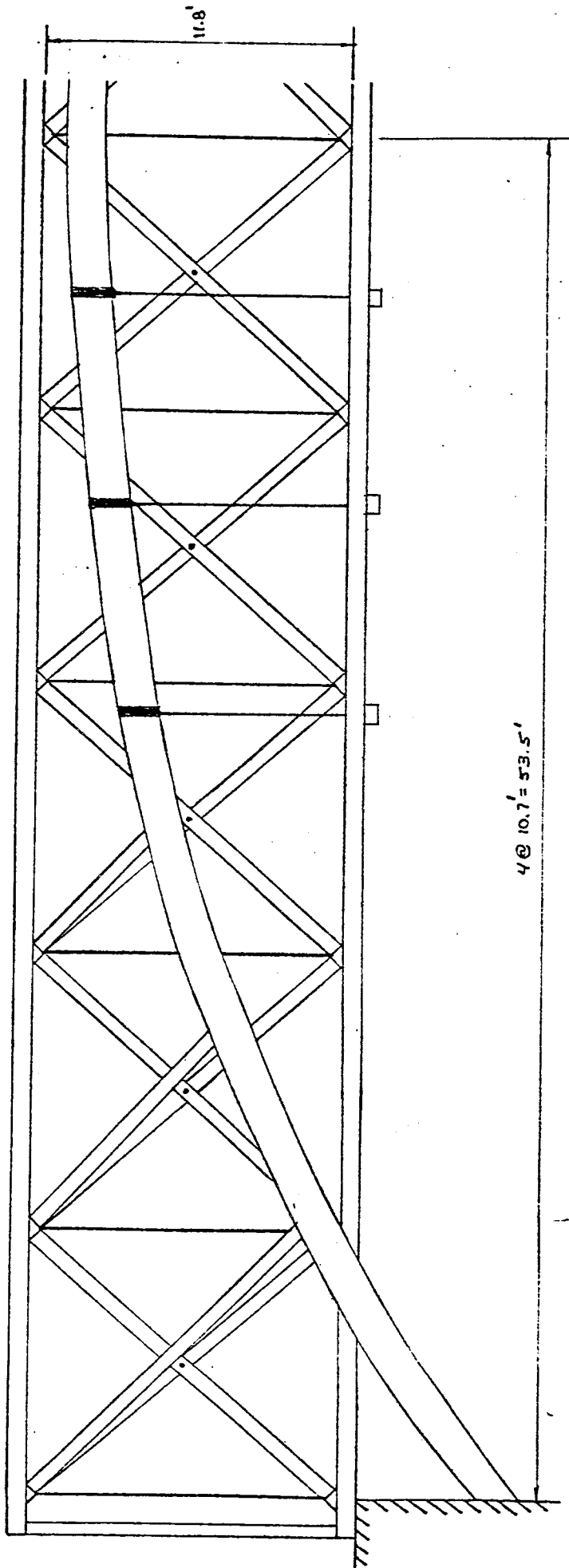

3. MILTON COVERED BRIDGE



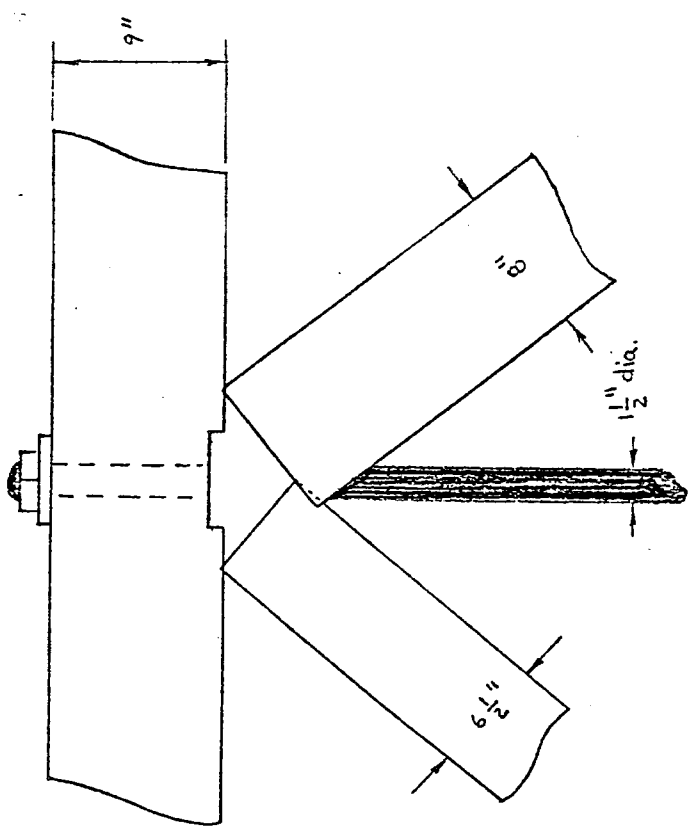
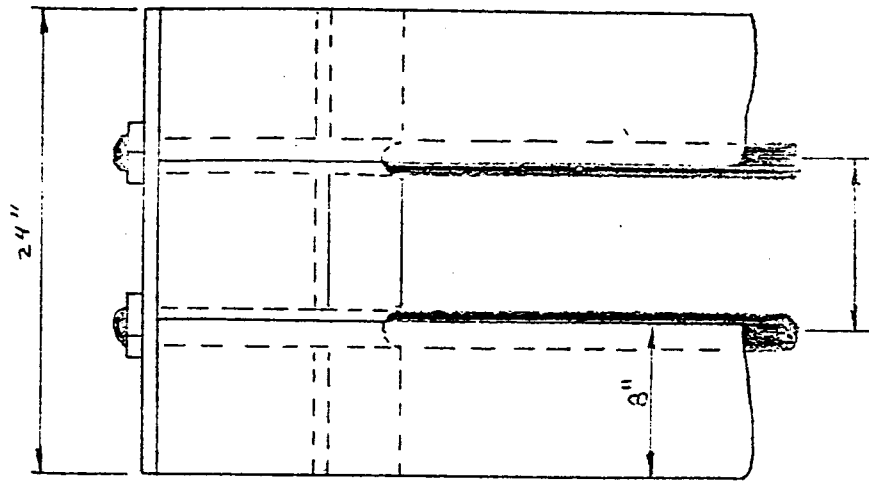

3. MILTON COVERED BRIDGE

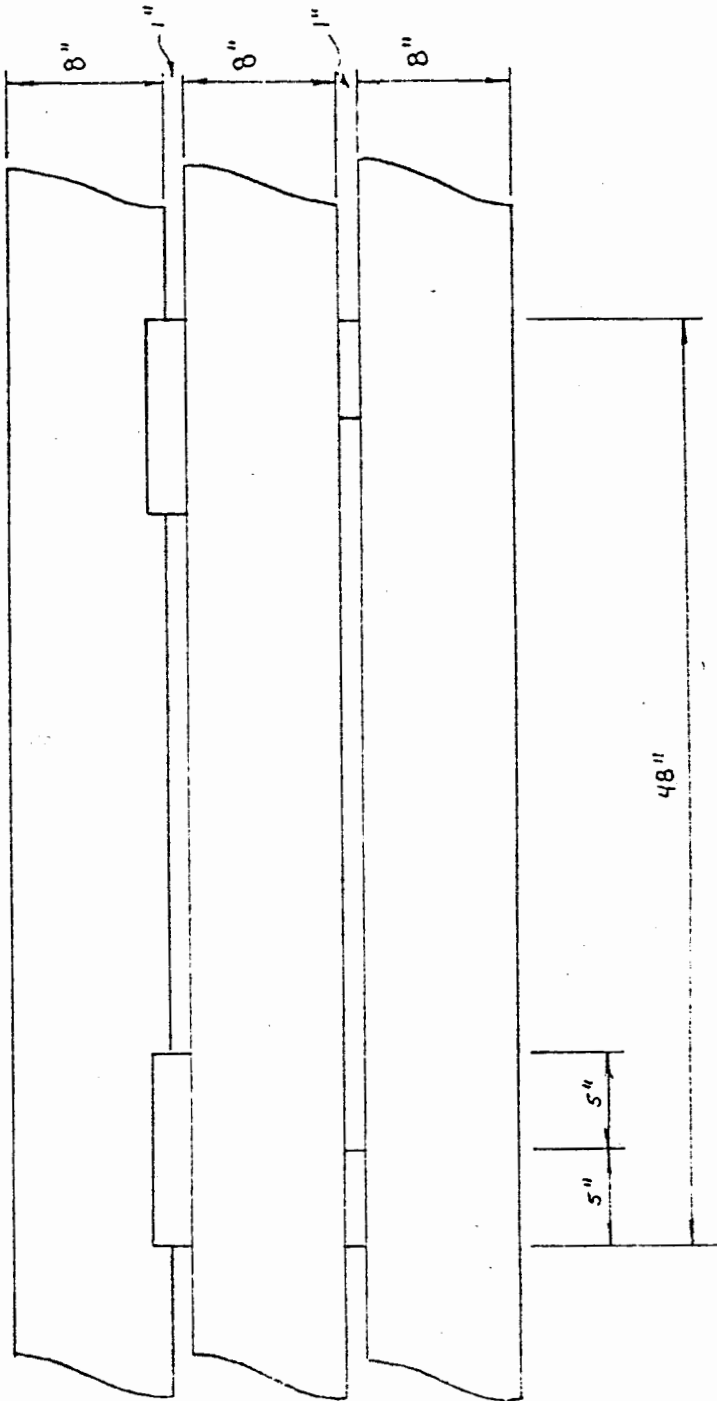

3. MILTON COVERED BRIDGE

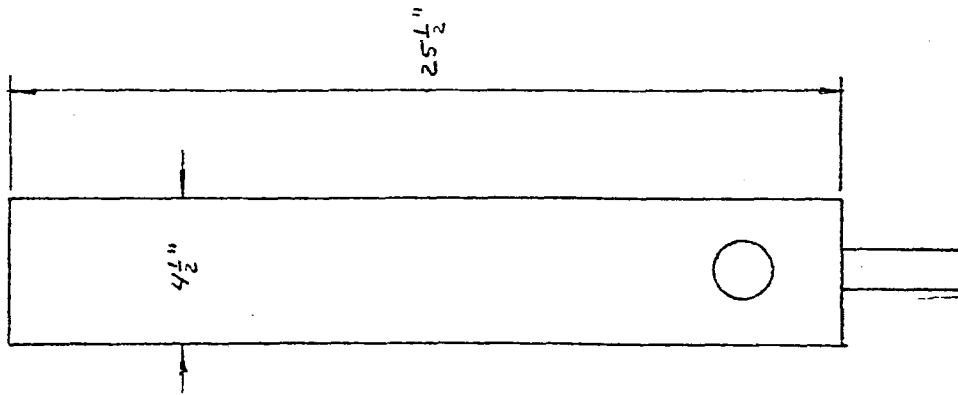
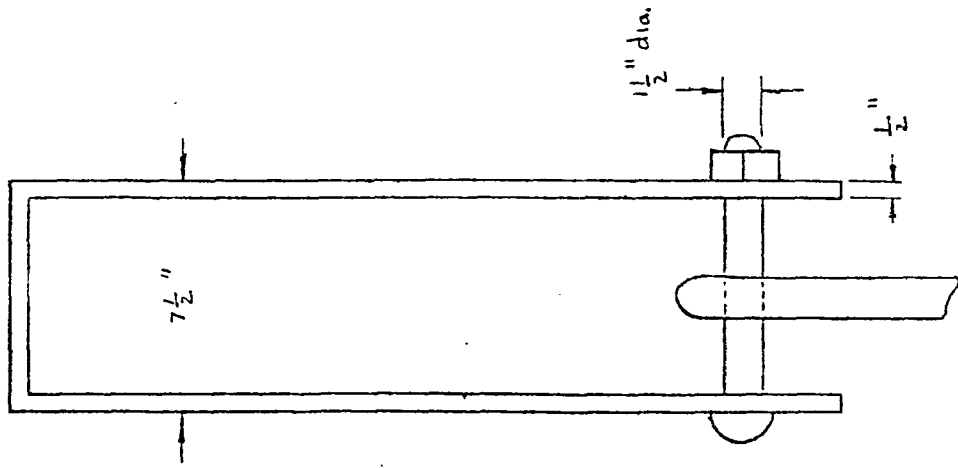

3. MILTON COVERED BRIDGE

1843  
BRIDGE MAINTAINED BY  
THE UNION ARMY  
1862-1865  
THE CONFEDERATES



THIS  
BRIDGE MAINTAINED BY  
THE UNION ARMY  
AGAINST  
THE CONFEDERATES